

CASIO SK-5

ELECTRONIC MUSICAL INSTRUMENT
 INSTRUMENTO MUSICAL ELECTRONICO

**OPERATION
 MANUAL 2**

**TABLEBEAST
 MODIFICATION 25**

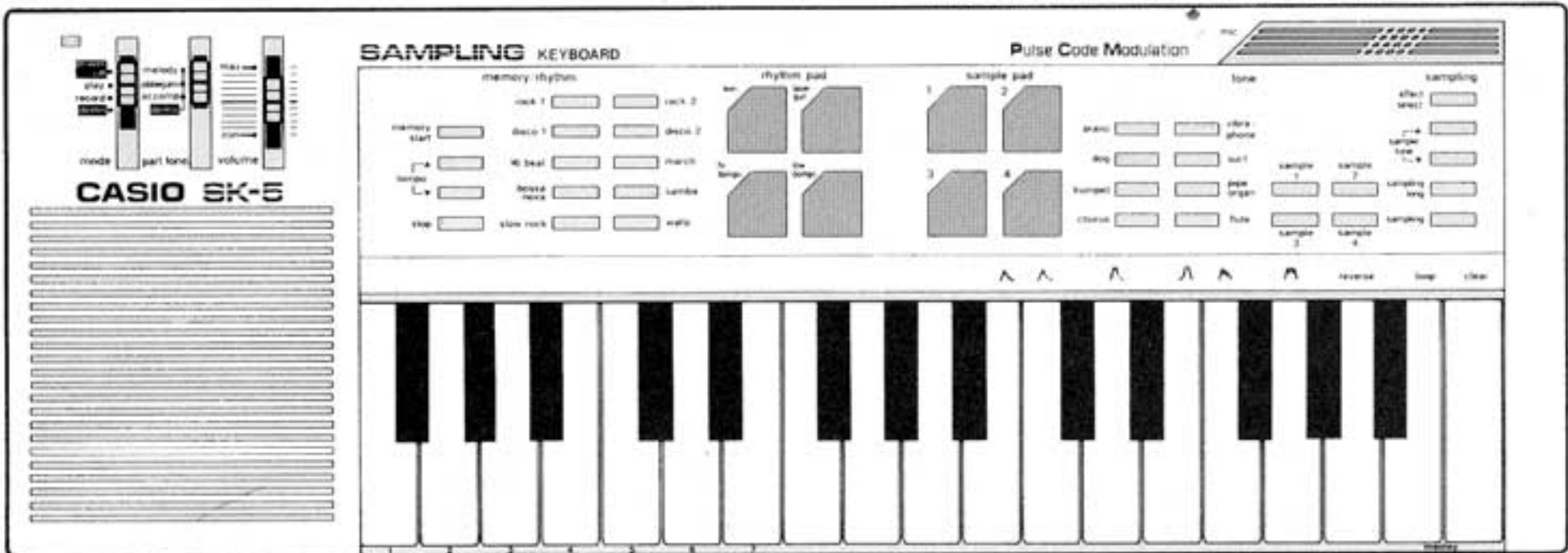

CASIO SK-5

ELECTRONIC MUSICAL INSTRUMENT

Thank you and congratulations on your purchase of the Casio SK-5 Sampling Keyboard. Your new keyboard features such functions as 4 sample sounds, 8 tones, 10 rhythms, as well as real-time memory, 7 demonstration tunes and 4 rhythm pads. Every sound from piano and trumpet to a dog's bark and rolling surf is PCM-produced.

To obtain optimum performance and assure long-term reliability, be sure to read this manual carefully before using this sampling keyboard.

Contents

1. Features & Functions	4
2. Power Supply	9
3. Preset Tones	11
4. Sampling Function	12
5. Auto-rhythms & Rhythm Pads	16
6. Demonstration Function	17
7. Real-time Memory	19
8. Troubleshooting	21
9. Care of Your Unit	22
10. Specifications	23
11. Tablebeast Modification	25
12. The ModKit & Parts	26
13. Installing the Patchbay	27
14. Testing the Mod	30
15. Playing your Modified Keyboard	31
16. Tips, Tricks & Pitfalls	32

1 Features & Functions

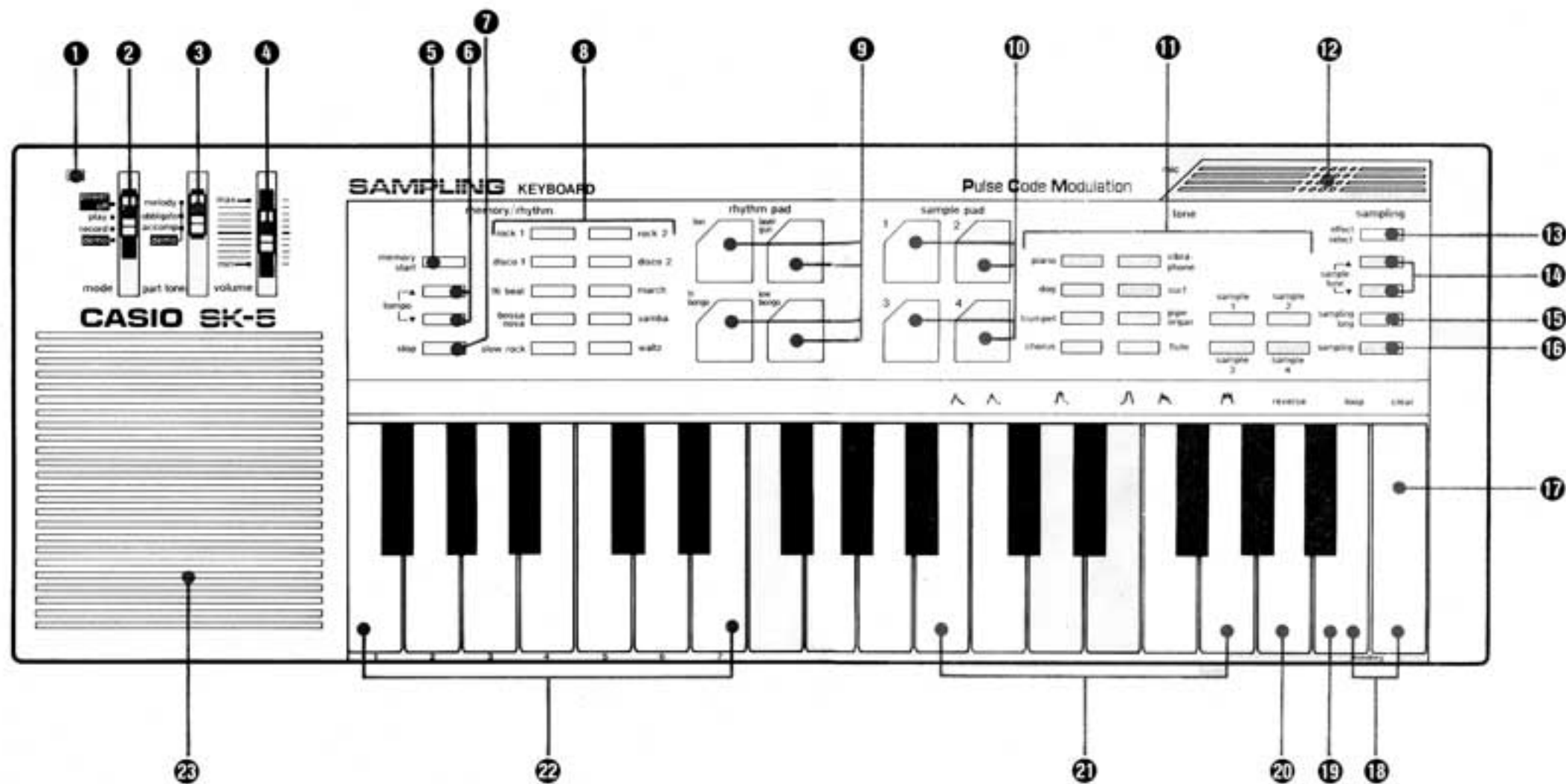

1. Features & Functions

- ① Power indicator**
- ② Mode selector**

Used to switch power on/off and to select one of the three modes.
- ③ Part tone selector**

Used to select a tone for each melody, obbligato, and accompaniment in the demonstration tunes.
- ④ Volume control**

Used to control overall volume.
- ⑤ Memory start button**

Used to start recording in real-time memory in the record mode, and to start playback of memory contents in the play mode.
- ⑥ Tempo control**

Used to raise or lower rhythm tempo.
- ⑦ Stop button**

Used to stop auto-rhythm, real-time memory, demonstration tune.
- ⑧ Auto-rhythm selectors**

Used to select preset auto-rhythms.
- ⑨ Rhythm pads**

Used to tap out 4 rhythm pad sounds.
- ⑩ Sample pads**

Used to tap out 4 sample sounds.
- ⑪ Tone selectors**

Used to select preset tones or sample sounds.
- ⑫ Built-in microphone**
- ⑬ Effect select button**

Used to select reverse effect and/or loop effect, desired envelope.
- ⑭ Sample tune buttons**

Used to adjust pitch of sampled sounds.
- ⑮ Sampling long button**

Used to perform 1.4-second sampling.
- ⑯ Sampling button**

Used to perform 0.7-second sampling.

17 Clear key

Used to clear sampled sounds after effect select button **13** is pressed.

18 Medley keys

Used to play 7 preset demonstration tunes successively in demo mode.

19 Loop key

Used to set loop effect after effect select button **13** is pressed.

20 Reverse key

Used to set reverse effect after effect select button **13** is pressed.

21 Envelope keys

Used to specify envelope of sampled sounds after effect select button **13** is pressed.

22 Demonstration tune keys

Used to select demonstration tunes from 1 to 7.

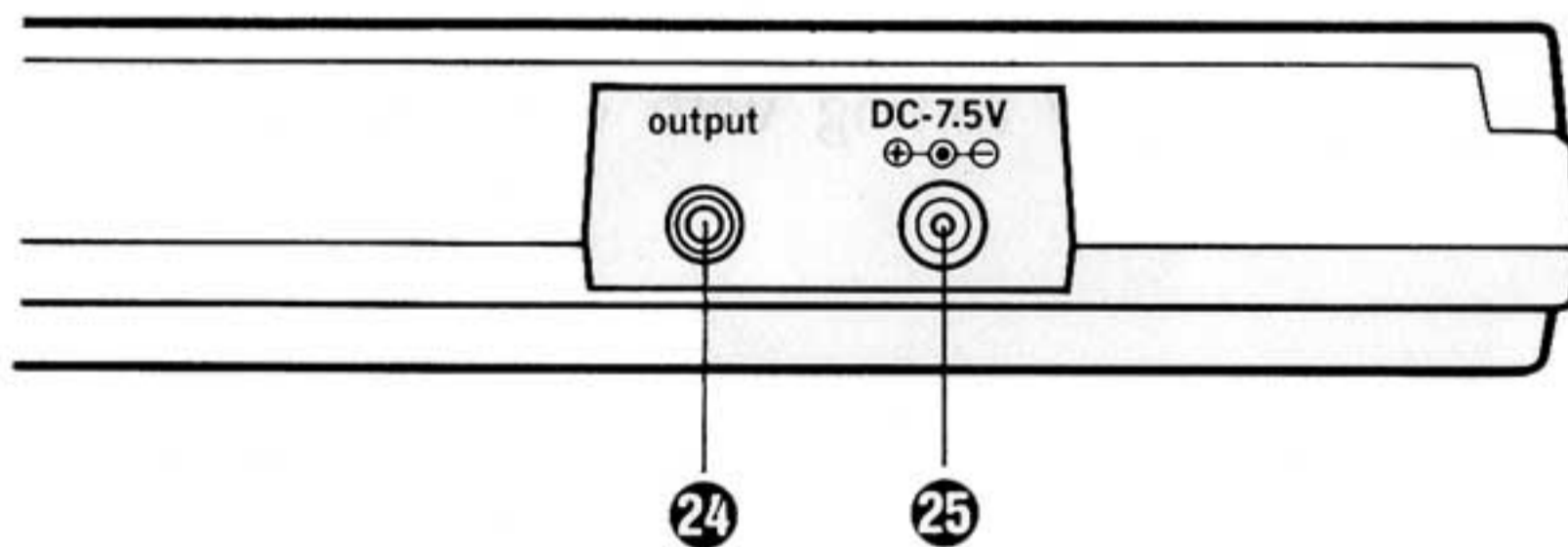
23 Built-in speaker**(Back panel)****24 Output jack**

For connection of optional headphones, audio amplifier or keyboard amplifier. Connecting headphones automatically cuts speaker output.

25 AC adaptor jack

For connection of optional AC adaptor (AD-1) or car adaptor (CA-1).

1. Features & Functions

(Right side panel)

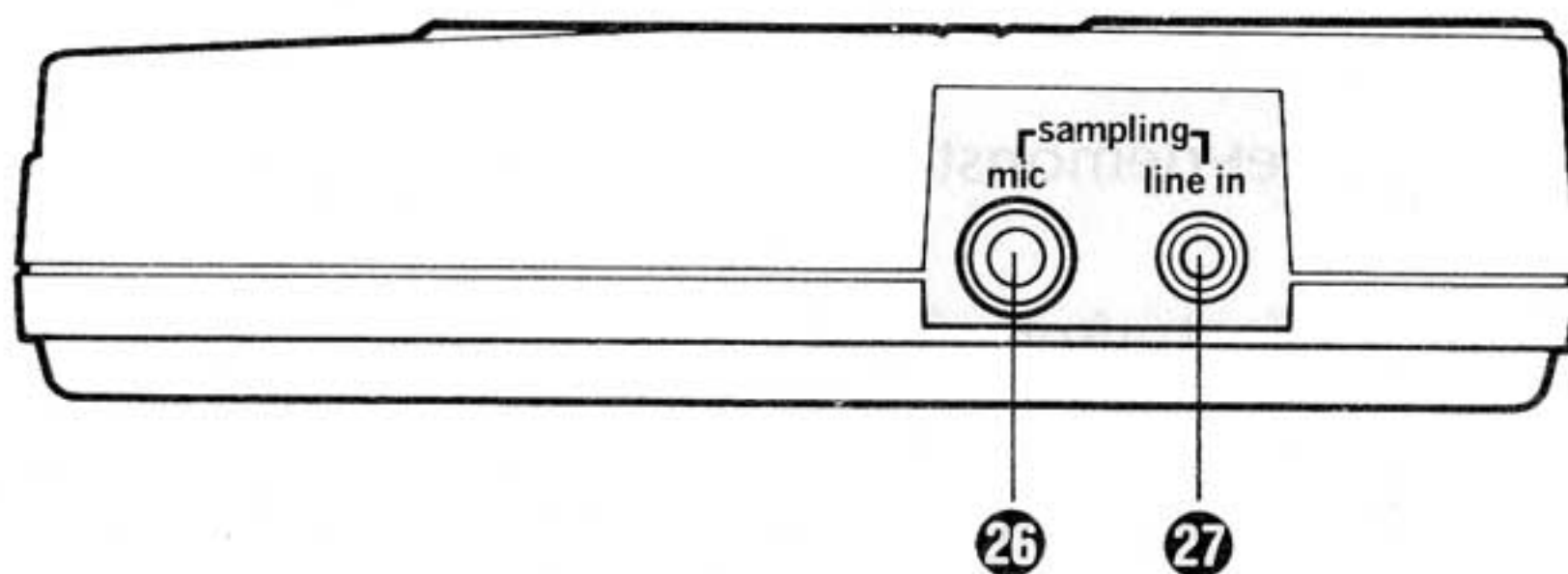

②⑥ Microphone input jack

For connection of external microphone for sampling sounds.

②⑦ Line input jack

For connection of audio equipment for sampling.

(Bottom panel)

②⑧ Tuning control

Adjusts the pitch of the entire keyboard within ± 30 cents and provides easy tuning with other instruments.

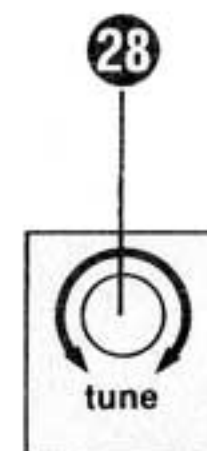

2 Power Supply

 This unit operates on both AC and DC power.

DC Power

• Dry batteries

This unit can be powered by five AA size (SUM-3) manganese dry batteries. Weakened batteries will result in lower volume or poor tonal quality. The power indicator lamp will gradually lose its brightness when battery power weakens. At this time, change batteries or shift to one of the alternate power sources mentioned below.

Battery replacement:

- ① Open the battery compartment cover on the bottom of the unit and take out used batteries.
- ② Load new batteries taking care that polarity is correct.
 - * *It is advisable to replace all five batteries at the same time for longer battery life.*
 - * *Refer to the specifications for standard battery life.*

• Car battery

With the car battery adaptor (CA-1, optional), DC power is supplied from a car battery through the cigarette lighter socket.

AC Power

An AC adaptor (AD-1, optional) is required to connect to an AC outlet. Use only an adaptor with the same voltage rating (100, 117, 220, or 240V) as the power supply in your area to prevent component damage. Plug the AC adaptor into the AC outlet and the cord into the unit. This will automatically cut off the battery power supply.

2. Power Supply

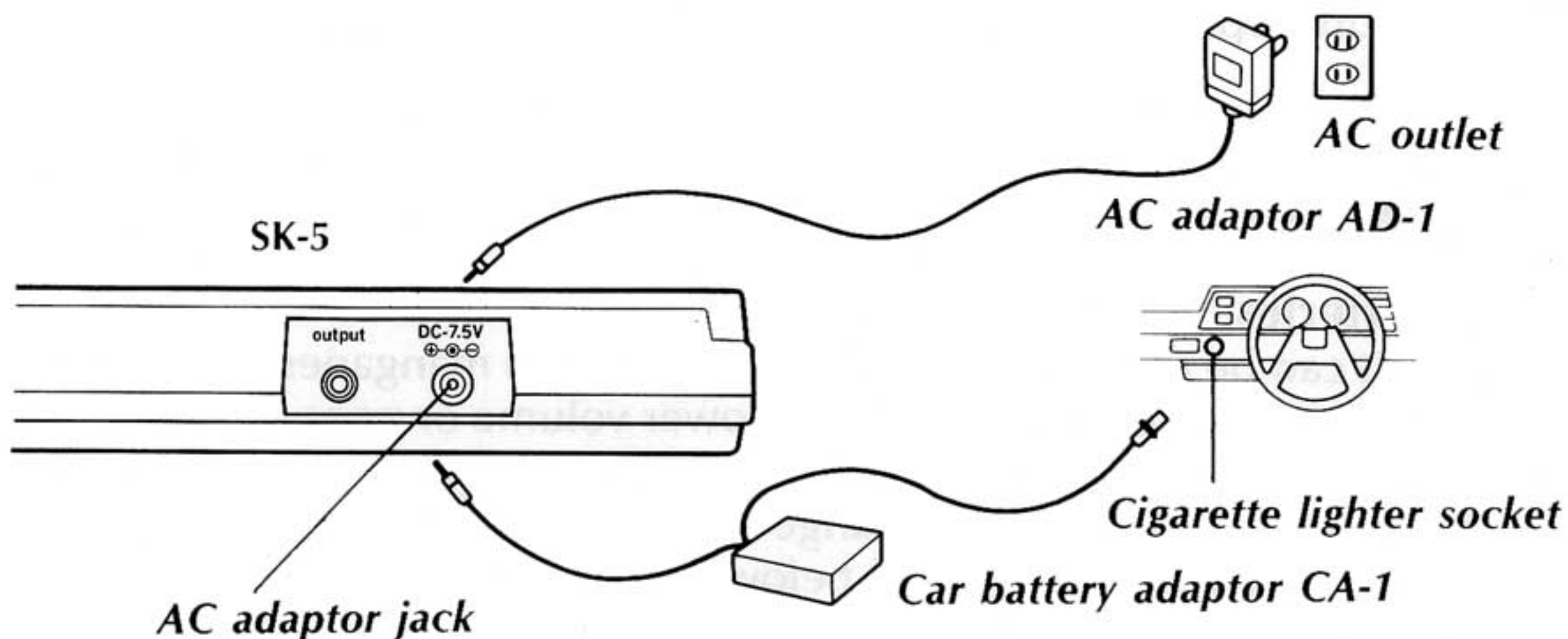

★ Auto power off function

Power is automatically cut off approximately 7 minutes after the last operation of the unit. Power supply can be restored by switching power OFF and then ON again.

CAUTION

- * Use only genuine CASIO adaptors to avoid risk of damage.
- * Remove batteries from the battery compartment when the unit is not used for extended periods. (Battery leakage can damage electrical parts.)
- * The adaptor may become warm when left connected to an outlet. This is normal, but the adaptor should be disconnected when not in use.
- * THE FOLLOWING CONDITIONS CAN CAUSE BATTERIES TO BURST:
 1. Use of adaptors other than genuine CASIO adaptors.
 2. Loading batteries with polarities reversed.

3 *Preset Tones*

 SK-5 is equipped with 8 factory preset tones including a dog's bark and rolling surf.

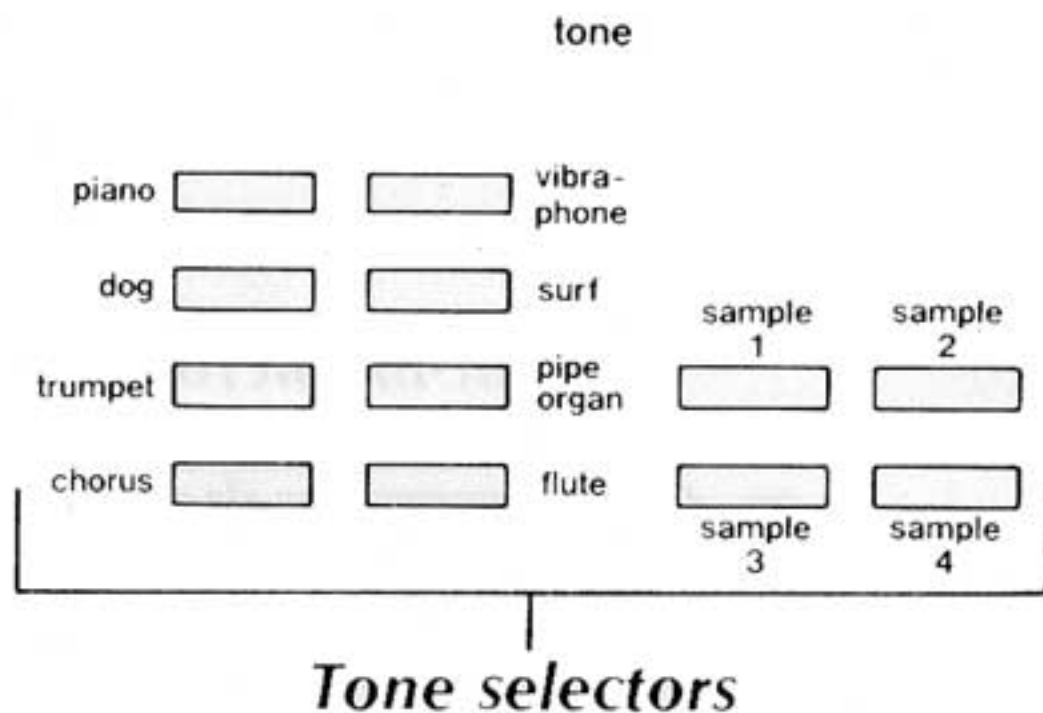

Mode selector

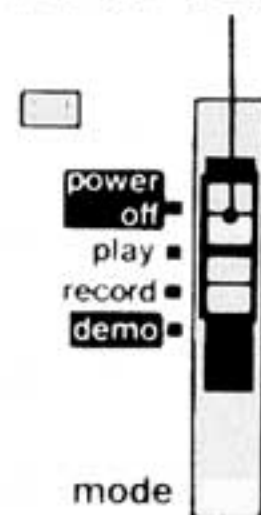

- Set the mode selector to “play”, and select the desired tone. Up to 4 notes can be played simultaneously on the keyboard (4-note polyphonic). The piano tone is selected immediately after power is turned on.

* *Sample buttons 1—4 are used to select sampled sounds keyboard play after sampling is performed.*

4 Sampling Function

With the SK-5, up to 4 sampled sounds can be stored using 0.7-second sampling. With 1.4-second sampling, up to 2 sampled sounds can be performed.

*Two sampling methods are available: direct PCM sampling using built-in microphone, and line input from another source such as a cassette tape recorder.

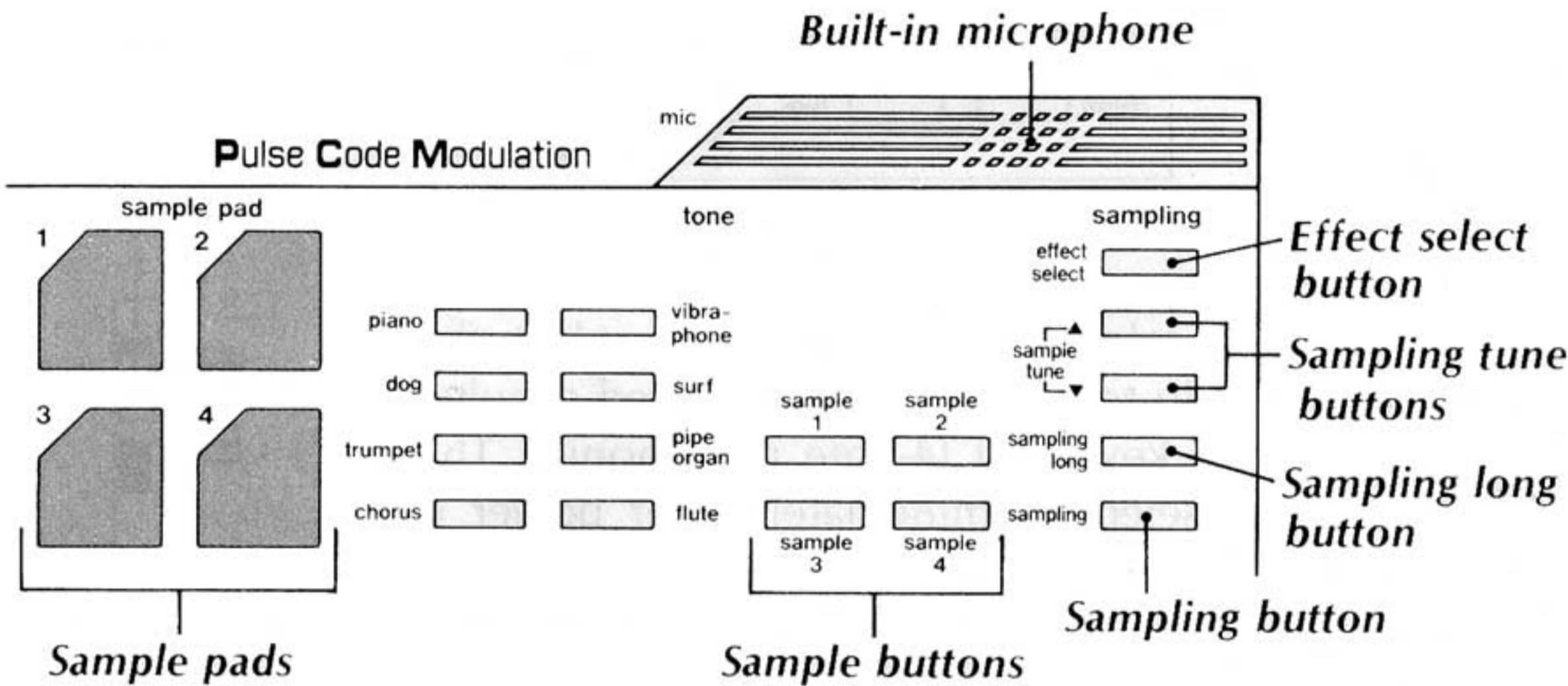

[SAMPLING PROCEDURE]

Sampling is always performed in the "play" mode.

① Select one of the 4 sample buttons.

* Press sample button 1 or 3 for long sampling.

* Sample 1 is automatically selected when sampling is performed without specifying a sample button.

② Press the sampling button.

* Press the sampling long button for 1.4-second sampling.

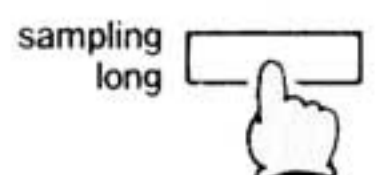
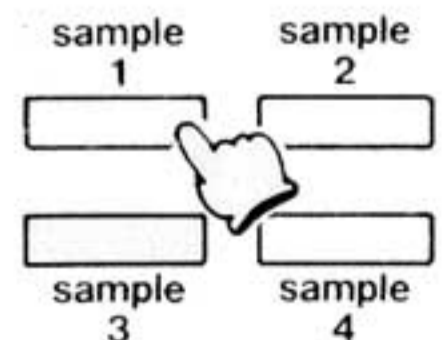
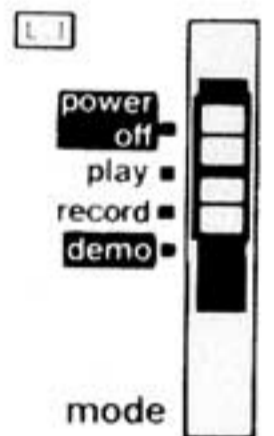

③ Enter the sound using the built-in microphone, an external microphone or line in.

* Any sampled sound previously present in the selected memory is deleted.

* A snare drum sound will be heard to indicate that sampling is complete.

* If no sound is entered for approximately 12 seconds, a bass drum sound will be heard to indicate that sampling standby is cancelled.

④ Now the sampled sound can be played on the 32 keyboard keys or tap out on the corresponding sample pads.

[LOOP, REVERSE, ENVELOPE]

Loop and/or reverse effects can be added to the sampled sound. Also, an envelope can be applied to the sampled sound.

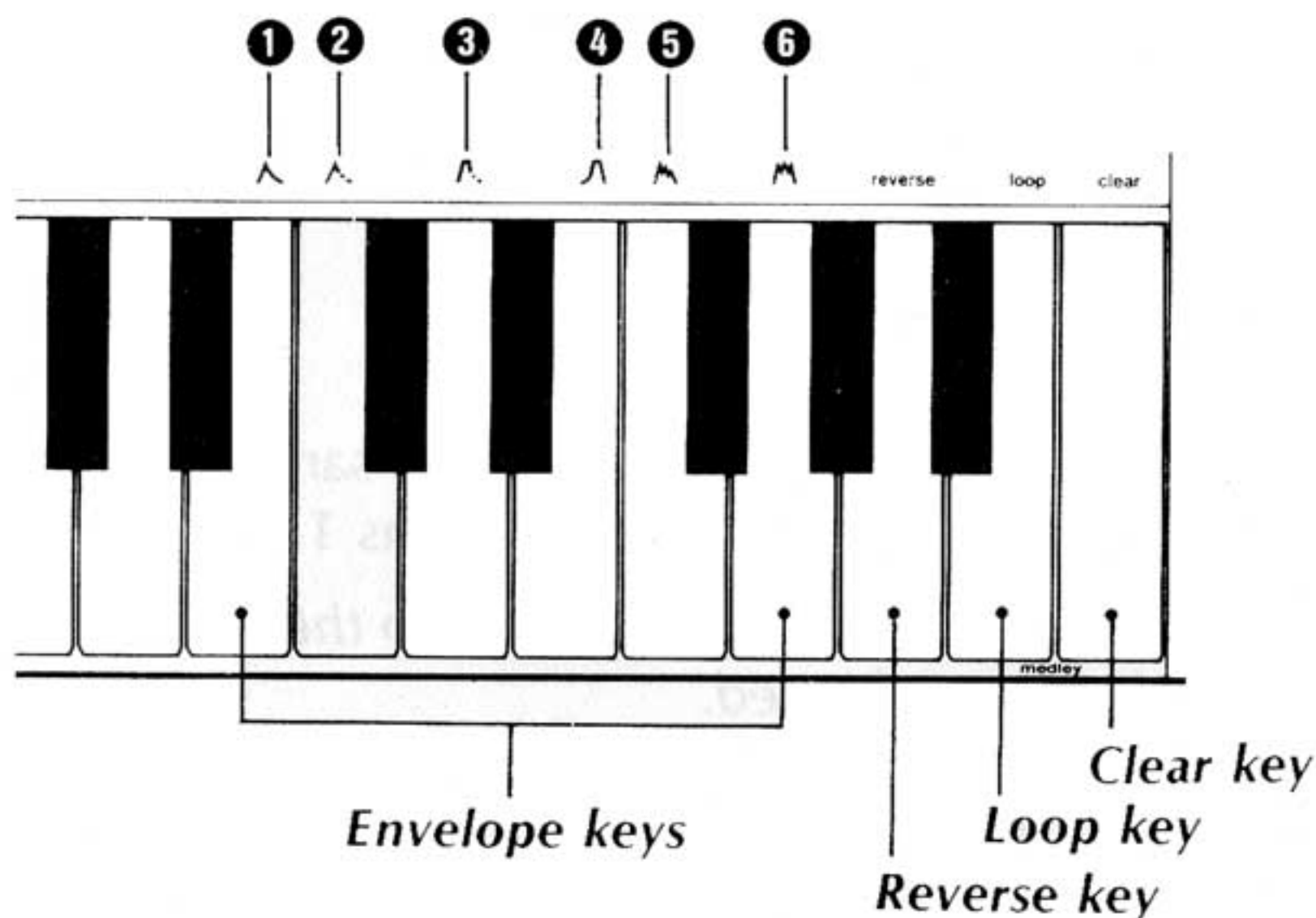

① Select one of the 4 sample buttons.

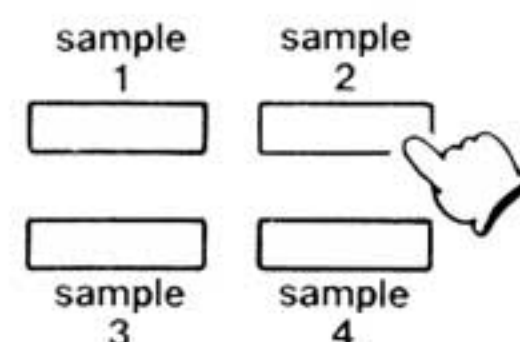

4. Sampling Function

② Press the effect select button followed by any desired effect key (loop, reverse, 6 envelopes).

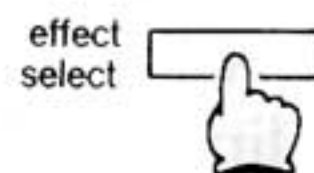

- * A snare drum sound will mark the engagement of the selected effect.
- * The reverse effect takes more time to apply than other effects. Continuous closed hi-hat sounds will be heard during internal processing until the final snare drum sound is heard.
- * Loop and reverse effects can be performed and cancelled by turns each time the effect key is pressed.
- * Three effects (loop, reverse, one of 6 envelopes) can be simultaneously applied to a sample sound.
- * All effects can be cancelled by pressing the effect select button followed by the clear key.

<6 envelopes>

- ① (\wedge).....Piano/guitar damped tone, slow decay.
- ② (\wedge).....Long release (damped tone), slower decay than ①.
- ③ (\wedge).....Reverb, some sustain after decay begins.
- ④ (\wedge).....Slow attack, slow increase of volume at beginning.
- ⑤ (\wedge).....Tremolo I, fade out with slight vibrato.
- ⑥ (\wedge).....Tremolo II, slight vibrato.

[SAMPLE PAD]

Sampled sounds can also be tapped out on the sample pads. Sample pads 1—4 correspond respectively to sample buttons 1—4.

- * The sounds of the sample pads correspond to the preset tones as follows when no sampling is performed.

sample 1.....piano
sample 2.....vibraphone
sample 3.....guitar
sample 4.....pipe organ

- *The pitch of sampled sounds played back with the sample pads corresponds to A4 of the keyboard.
- *4 sample pad sounds can be simultaneously played back in the play and record modes.

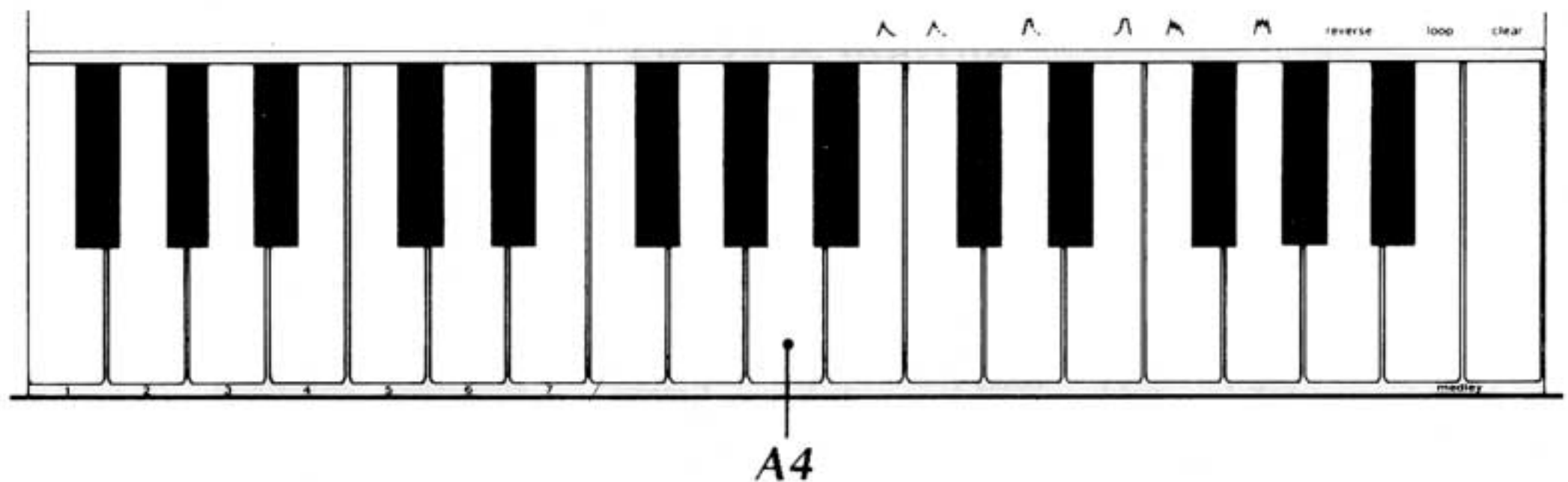

[SAMPLE TUNE]

The pitch of sampled sounds can be easily tuned to standard pitch (A4=442Hz) with the sample tune function.

- ① Press one of 4 sample buttons to be tuned, followed by either of the sample tune buttons (▲) (▼).

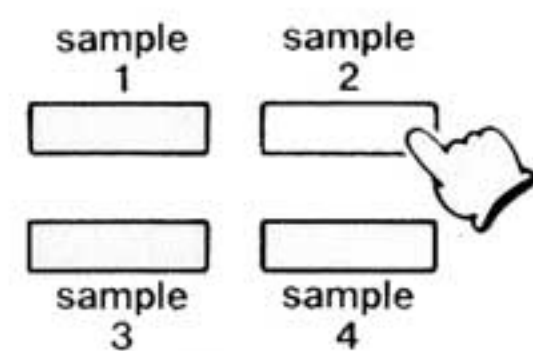

- * A continuous sound in the standard pitch (A4=442Hz) will be heard together with the sampled sound for comparison.

- ② Hold down the tune up button (▲) to raise the pitch, or the tune down button (▼) to lower the pitch. Release the button at the point where the standard pitch sound and the sampled sound are tuned.

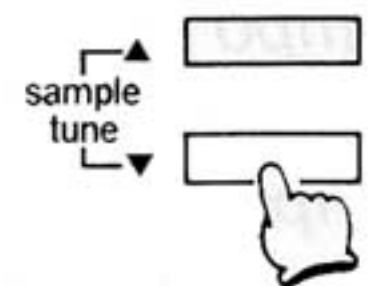

- * The pitch of the sampled sound can be changed in the range of one octave, with the original pitch being at the mid-point of the octave.
- * Simultaneously pressing the tune up(▲) and down(▼) buttons allows comparison between the sampled sound and standard pitch (A4=442) without raising or lowering the original pitch of the sampled sound.
- * Sample pad sounds are also set at the adjusted pitch.

5 Auto-rhythms & Rhythm Pads



The SK-5's auto-rhythm function features a total of 10 different rhythms, and 4 rhythm pads. 4 of the preset rhythm sound sources (hi bongo, low bongo, lion's roar, laser gun) can be tapped out on these pads.

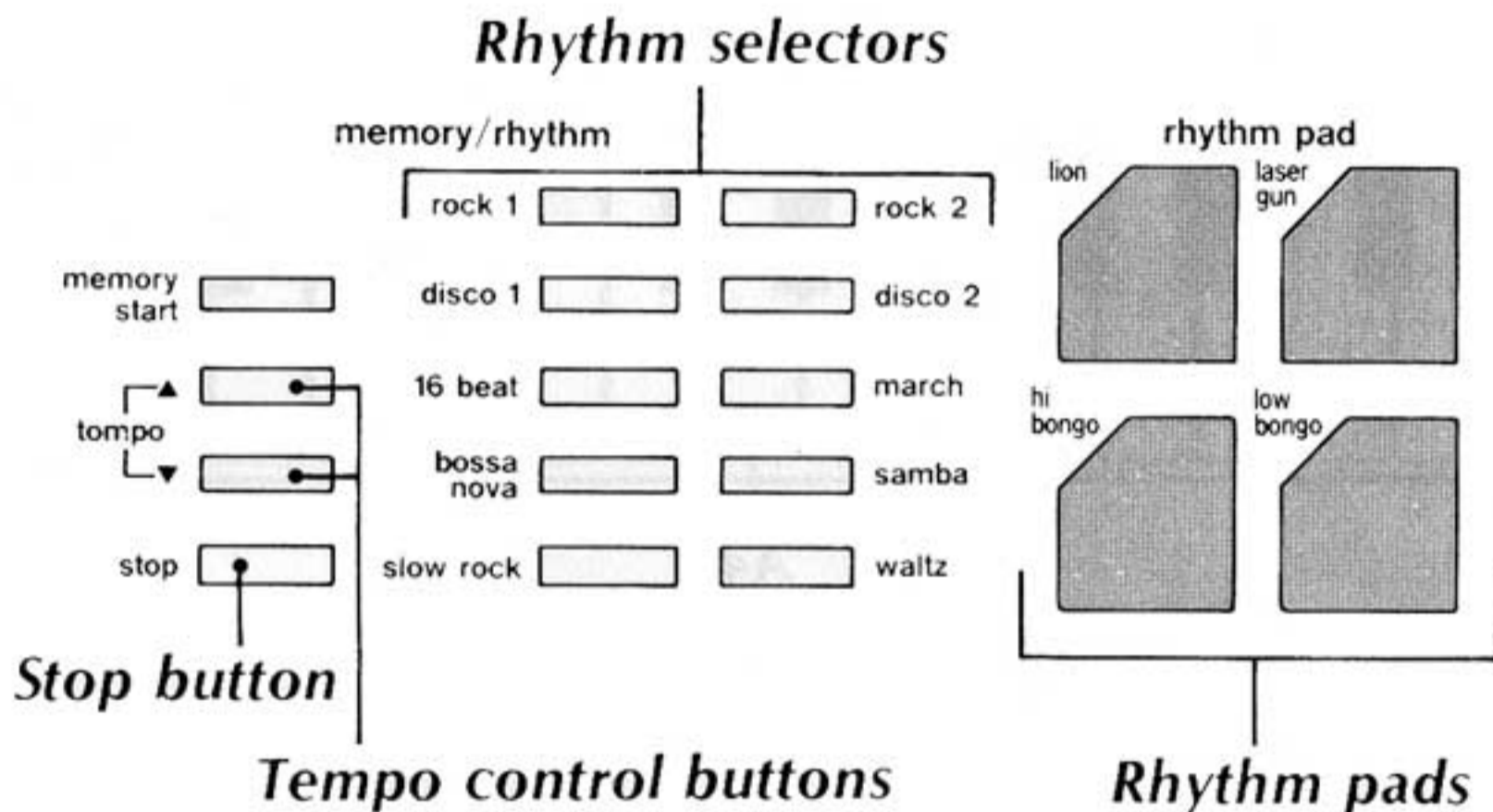

[AUTO-RHYTHMS]

Set the mode selector to "play", and press one of 10 auto-rhythm selectors to start an auto-rhythm.

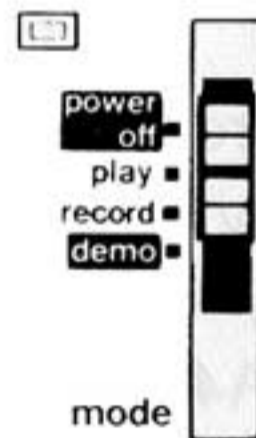

- * Press the stop button to stop rhythm play.
- * Tempo can be set in the range of $\text{♩} = 54 - 254$ using the tempo control buttons. Pressing the two tempo control buttons at the same time sets tempo to $\text{♩} = 110$.

[RHYTHM PADS]

Simply tap a pad to produce the sound noted on the panel.

- * 4 rhythm pad sounds can be played simultaneously.

6 Demonstration Function

 The SK-5 features 7 built-in demonstration tunes.

- 1.....Picnic (English folksong)
- 2.....Turkish march (Mozart)
- 3.....Clair de lune (Debussy)
- 4.....Eine kleine nacht musik (Mozart)
- 5.....Surprise symphony (Haydn)
- 6.....Jingle bells (Pierpont)
- 7.....American patrol (Meacham)

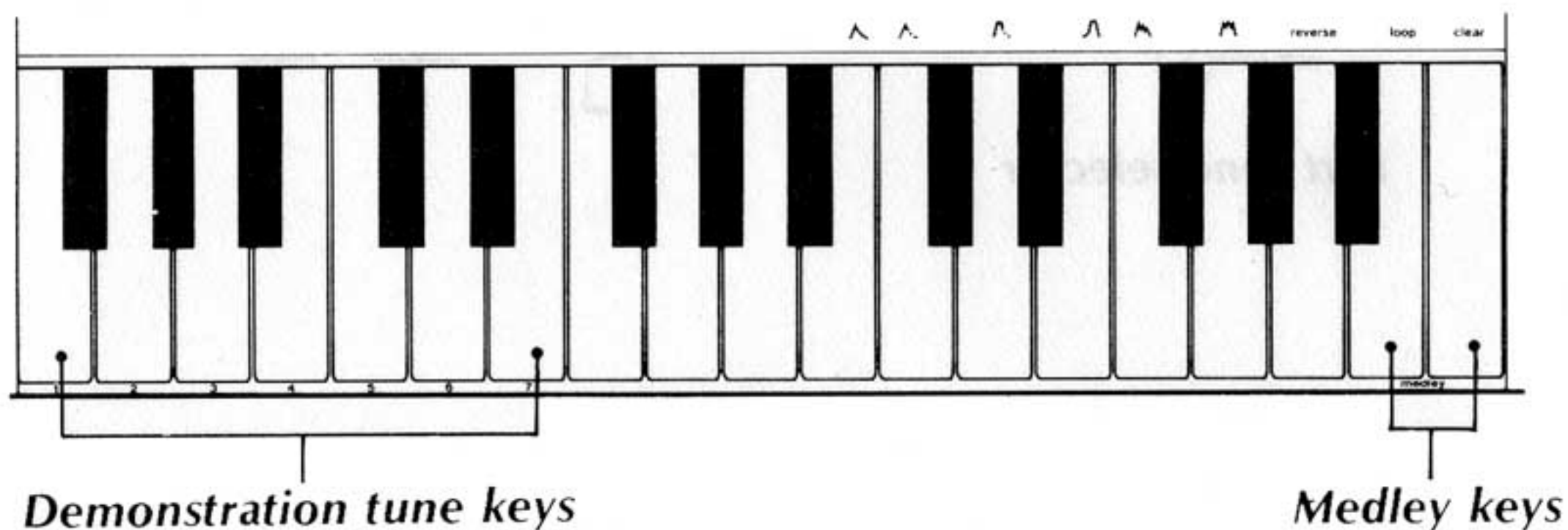

- Set the mode selector to "demo", and select the tune number using the demonstration tune keys. The tune starts.

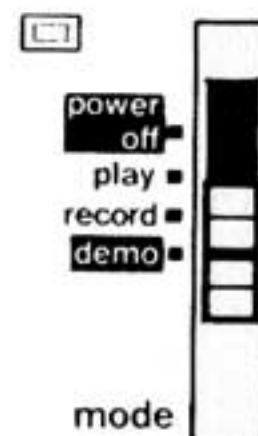

- * *Tempo can be changed using the tempo control buttons.*
- * *7 tunes are played successively, when either medley key is pressed.*

6. Demonstration Function

[PART TONE SELECT]

Each part of the demonstration tunes can be changed to any of the preset tones. Set the part tone selector to one of the three parts ("melody", "obligato", "accomp"), and press the desired preset tone followed by the tune key. The tune is played with the part tone changed as selected.

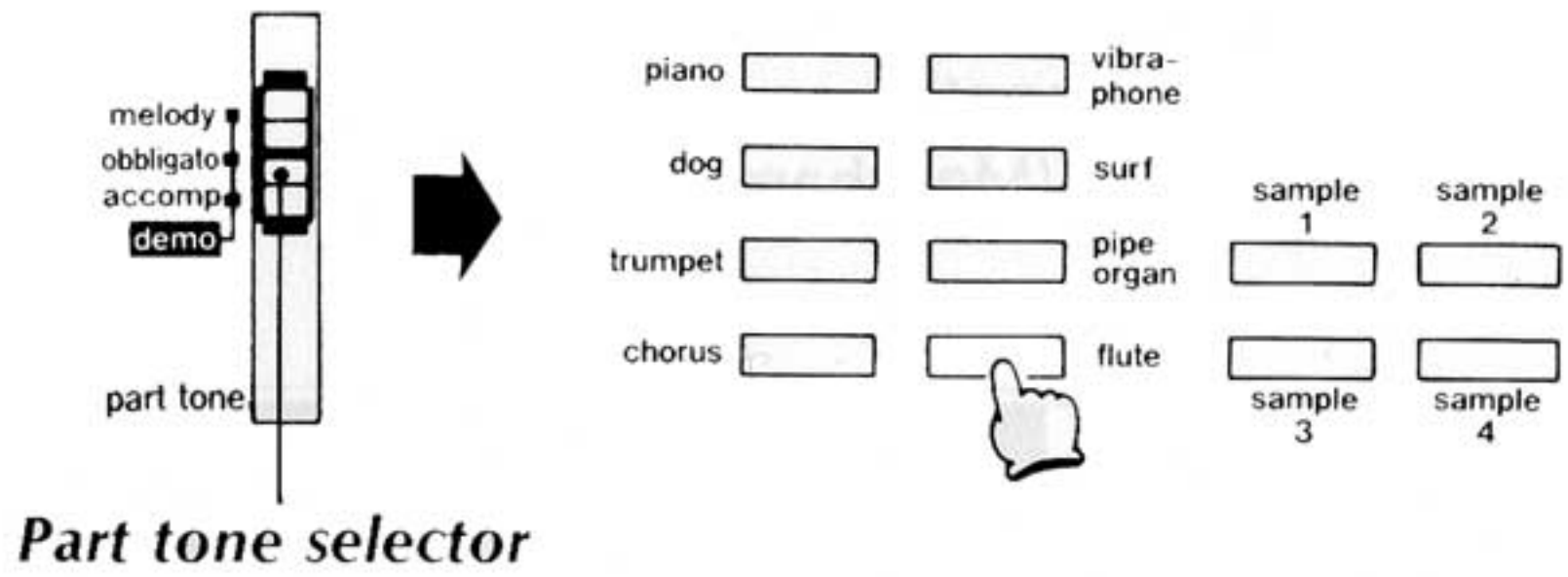

7 Real-time Memory

The real-time memory function of the SK-5 makes it possible to record and store tunes in memory for later playback. Stored tunes are retained in memory even when the power of the unit is switched off.

[RECORDING]

① Set the mode selector to "record".

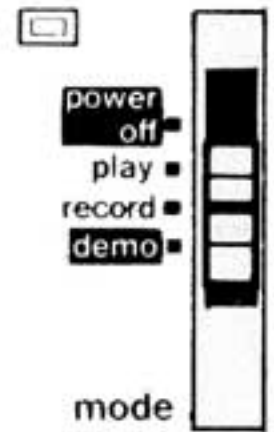

② Press the memory start button.

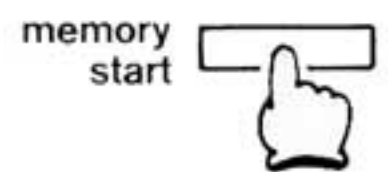

- * Recording starts with a count sounding.
- * Select an auto-rhythm if desired before pressing the memory start button.
- * If an auto-rhythm was not selected, recording starts as soon as a keyboard key or a pad is played, or when an auto-rhythm is started.
- * An auto-rhythm can be added at any time during recording by pressing the auto-rhythm selector.
- * Any data previously stored in memory are deleted.

③ Press the stop button to stop recording.

- * Recording can be halted at any time by pressing the stop button.

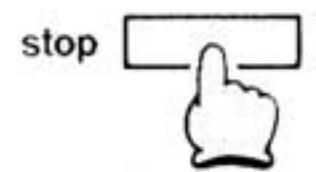

- Total memory capacity is 496 steps, with one step being defined as follows:
 - Keyboard play: 1 step/note
 - Sample pad play: 1 step/operation
 - Rhythm pad play: 0.5 step/operation
- Record operations are automatically terminated when memory capacity is exceeded.

7. Real-time Memory

[PLAYBACK]

① Set the mode selector to “play”.

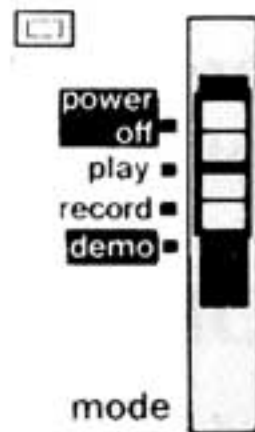

② Press the memory start button.

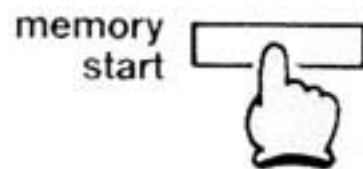

* *Playback returns to the beginning and continues to play in an endless loop when the end of the recorded tune is reached.*

8 Troubleshooting

**For any malfunction, always check battery condition first. (see page 9)*

Symptoms	Possible cause	Remedy
No sound even when keys are pressed.	Volume control at minimum.	Reset volume control.
Occasional interference.	Refrigerator, washing machine or other electrical appliance.	Use outlet as far away as possible from appliance thought to be cause.
No sound when connected to external amplifier.	1. Keyboard volume set at minimum. 2. Defective connection cord.	1. Adjust keyboard volume control. 2. Connect correctly.

9 *Care of Your Unit*

1. Avoid heat, humidity, and direct sunlight.

Do not overexpose the unit to direct sunlight, place it near a heater, or in any area subject to high temperature.

2. Avoid severe impacts and do not drop.

Severe impacts can result in malfunction. When carrying or transporting the unit, protect the keyboard and buttons by packing with soft cloth.

3. Keep the unit free of liquids, dust, particles, etc.

Do not allow foreign matter to enter between the keys. Be especially careful of metallic objects such as hairpins, sewing needles or coins. Also, do not allow the unit to get wet.

4. Never attempt to modify any part of the unit.

Your keyboard is a precision musical instrument made up of sophisticated electronic parts. Any modification of, or tampering with internal components can cause trouble or malfunction.

5. Do not use lacquer thinner or similar chemicals for cleaning.

Clean the keyboard with a soft cloth dampened with a mild detergent solution. Soak the cloth in the detergent solution and squeeze it until almost dry.

6. Remove batteries before extended storage.

Batteries left in the unit for long periods can leak and cause damage to electronic circuitry.

7. In case of malfunction...

Check whether buttons and connections are set correctly as indicated in the troubleshooting chart. If the unit still does not work properly, contact the original retailer or a nearby dealer. Never attempt to repair the unit yourself. This can result in serious damage of the components.

10 Specifications

Model:	SK-5
Number of keys:	32 mini keys
Polyphonic:	4-note polyphonic
Preset tones:	8 (piano, vibraphone, dog, surf, trumpet, pipe organ, chorus, flute)
Auto-rhythms:	10 (rock 1—2, disco 1—2, 16 beat, march, bossa nova, samba, slow rock, waltz)
Rhythm source:	Pulse Code Modulation
Sampling rate:	8-bit
Sampling time:	0.7-second sampling (× 4) 1.4-second sampling (× 2)
Sample tune:	±1 octave
Built-in speaker:	8cm dia. (Output=1W)
Built-in pads:	4 sample pads 4 rhythm pads (lion, laser gun, hi bongo, low bongo)
Real-time memory:	496 steps
Terminals:	Output; Output impedance=68 Ω Output voltage=1.6 V (RMS) max. Mic; Input impedance=10 KΩ Input sensitivity=4 mV Line in; Input impedance=100 KΩ Input sensitivity=100 mV
Power:	5 AA-size dry cells, AC adaptor AD-1 (option) or car adaptor CA-1 (option)
Auto power off function:	7 minutes after last operation
Power consumption:	1.8W

10. Specifications

Dimensions: 470 (W) × 169 (D) × 47 (H) mm
[18 1/2'' (W) × 6 5/8'' (D) × 1 13/16'' (H)]

Weight: 1.3 kg (2.9 lb)

Standard accessories: 5 AA-size manganese dry batteries

**Design and specifications are subject to change without notice.*

GUIDELINES LAID DOWN BY FCC RULES FOR USE OF THE UNIT IN THE U.S.A. (not applicable to other areas).

This equipment generates and uses radio frequency energy and if not installed and used properly, that is, in strict accordance with the manufacturer's instructions, may cause interference to radio and television reception. It has been type tested and found to comply with the limits for a Class B computing device in accordance with the specifications in Subpart J of Part 15 of FCC Rules, which are designed to provide reasonable protection against such interference in a residential installation. However, there is no guarantee that interference will not occur in a particular installation. If this equipment does cause interference to radio or television reception, which can be determined by turning the equipment off and on, the user is encouraged to try to correct the interference by one or more of the following measures:

- reorient the receiving antenna
- relocate the computer with respect to the receiver
- move the computer away from the receiver
- plug the computer into a different outlet so that computer and receiver are on different branch circuits.

If necessary, the user should consult the dealer or an experienced radio/television technician for additional suggestions. The user may find the following booklet prepared by the Federal Communications Commission helpful: "How to Identify and Resolve Radio-TV Interference Problems." This booklet is available from the US Government Printing Office, Washington, D.C., 20402, Stock No. 004-000-00345-4.

CASIO[®]